



CARAVITA[®]

Exclusive parasols and sun sails

2022 Innovations



Centro

Robust restaurant parasol

The Centro central pole parasol is a solid sun shading product for parasol sizes up to 5 m span. Ideally suitable for any restaurant's outdoor area.

You can find more information on page 24 or click: www.caravita.eu/centro



Scala

Function meets design

With its optional rotating pedal as well as its WMS motor drive on demand, this elegant cantilever parasol adds even more details to its flexibility. With a span of 4 m and its modern design, Scala is definitely not to go unnoticed on any terrace.

You can find more information on page 56 or click: www.caravita.eu/scala

CARAVITA Designer

With the CARAVITA Designer, our parasols can be experienced in your own home as smart app applications using Augmented Reality.



The AR App for visualisation

The CARAVITA Designer is your configurator for the virtual planning of your parasol. Through the Augmented Reality app, BIG BEN and Co can be easily configured, and your personal location of use can be visualised.

The free app is quick and easy to install, and lets you experience live how your parasol will look on patios, balconies, or in the garden. You can set the size, select a suitable parasol fabric and configure frame colour, motorisation and other extras. The AR app is available for iOS and for Android.

You can find more information about the app here: www.caravita.eu/designer



CARAVITA
AR Designer

It's this easy

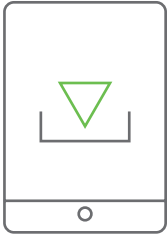

1. Download the "CARAVITA AR Designer" app for free from the App Store (iOS) or the Play Store (Android). Visualisation is best suited for a tablet, but is also possible using a smartphone.

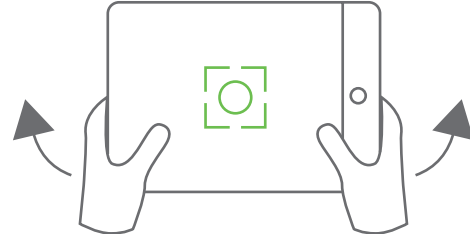

2. Open the app, select a parasol model and scan the ground.

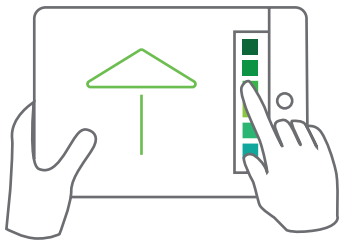

3. Configuration of size, colour, fabric and many extras.

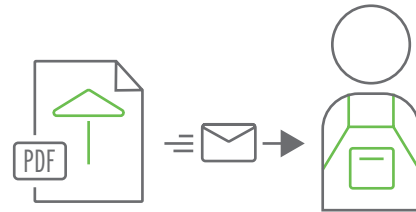

4. Save the configuration as a PDF and obtain a non-binding price estimate from a local CARAVITA specialist partner.

CARAVITA

The sustainable summer manufacturer

At CARAVITA, you don't just get a run of the mill parasol, but a robust and reliable shading system tailored to your personal requirements. You determine: size, colour, fabric, design and extras such as radiant heaters, led lighting, motor drive or intelligent remote control. Each parasol is custom-made with quality craftsmanship according to your personal requirements. Your unique parasol is the product of over 25 years of experience in the industry, great passion and high-grade materials, allowing you to enjoy the best outdoor moments of the year.

Our local specialist partners will be happy to advise you personally about our solutions on site. With our visualisation app, our expert hotline, our 5-year warranty and our service technicians, we not only accompany you before and during your purchase, but also with a permanent after sales service.

At WAREMA, we attach great importance to the sustainability of our products and our social responsibility as a company. In this way, we want to make our contribution for a better world and a future worth living in. To achieve this goal, we not only ensure the durability of our products through the use of high-grade materials, but also spare parts that can be replaced without any problems. And regarding our ethics towards production and logistics we engage in our daily improvement in making our processes even more resource-friendly.

Discover the unique world of CARAVITA at www.caravita.eu



5 YEAR
WARRANTY*

*5 years in accordance with our warranty conditions which can be found at www.caravita.eu/warranty

CARAVITA - Get yet another parasol

At CARAVITA. you don't just get any parasol, but a high-grade and reliable shading system tailored to your personal requirements.

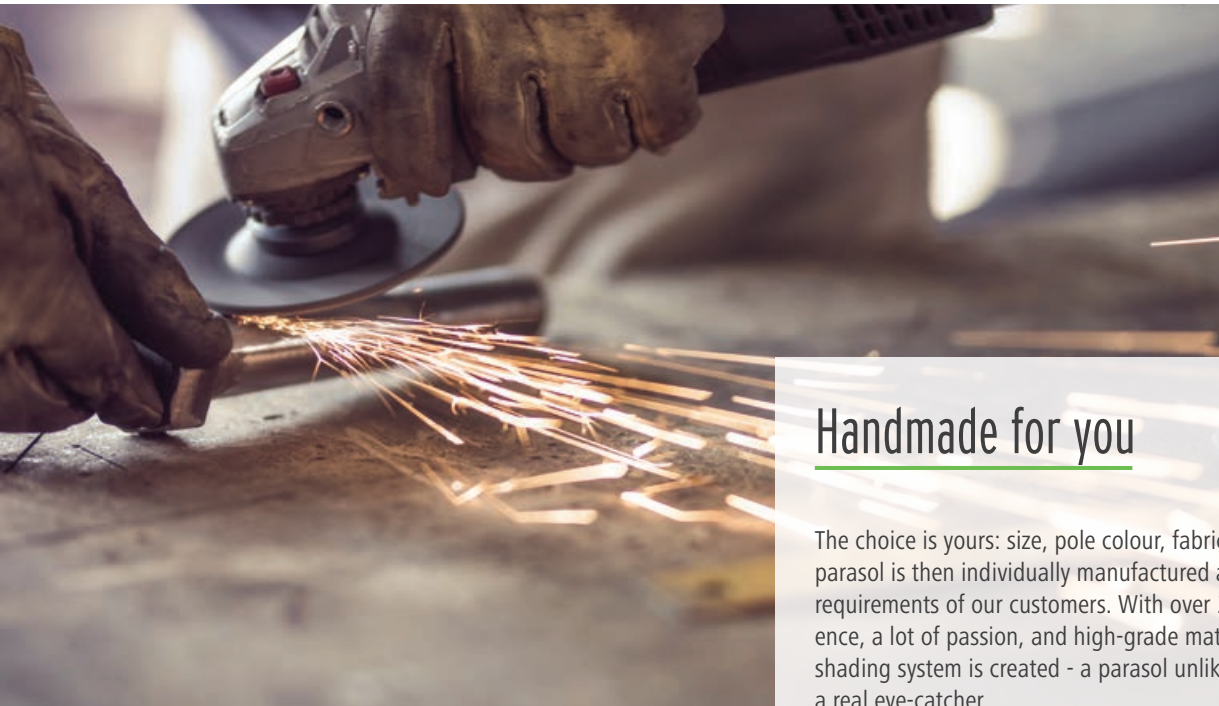

Handmade for you

The choice is yours: size, pole colour, fabric design. Each parasol is then individually manufactured according to the requirements of our customers. With over 25 years of experience, a lot of passion, and high-grade materials, your unique shading system is created - a parasol unlike like any other and a real eye-catcher.

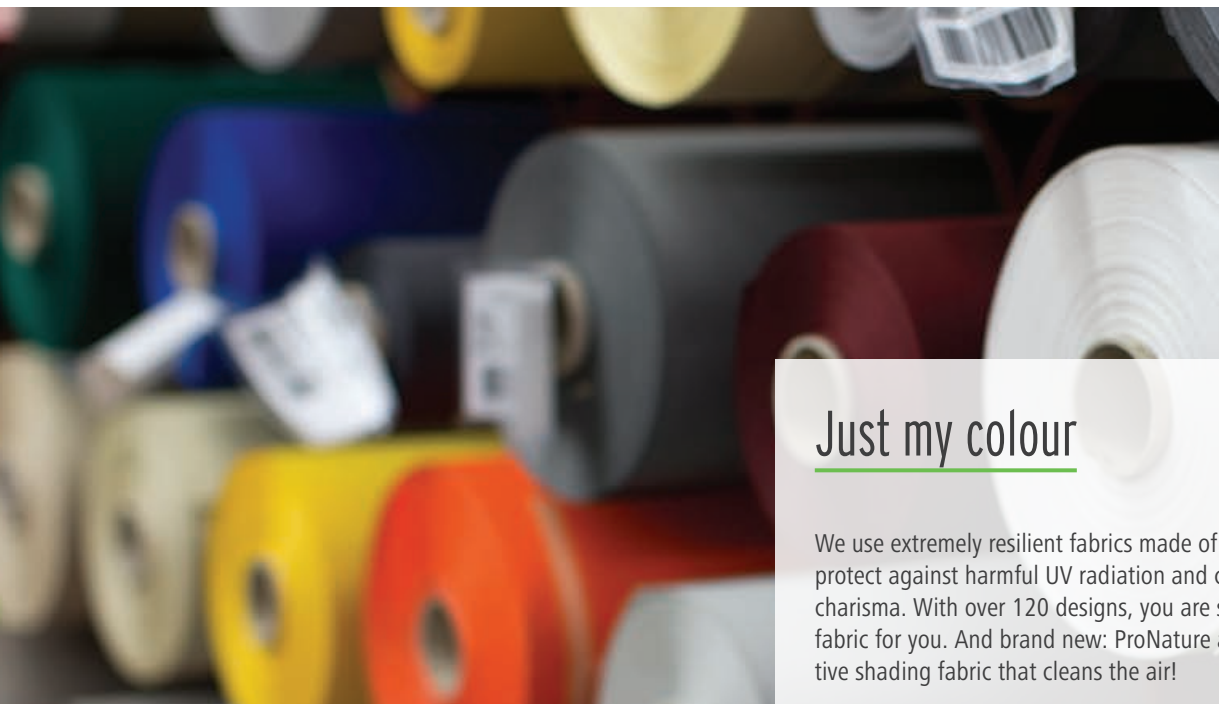

Just my colour

We use extremely resilient fabrics made of acrylic fibres. These protect against harmful UV radiation and convince with their charisma. With over 120 designs, you are sure to find the right fabric for you. And brand new: ProNature acrylic – the innovative shading fabric that cleans the air!



The material makes all the difference

CARAVITA parasols are made of high-grade aluminium. Reinforced struts, a solid hub and a pole with up to 120 mm diameter and 5 mm wall thickness are not only more than most parasols on the market, but also guarantee extreme wind stability and durability. We also guarantee this with our 5-year warranty*.



On-site contact

Would you like a personal consultation, would you like to see CARAVITA parasols live or are you interested in an installation? No problem: we are sure to have a competent specialist partner in your area who will take care of your needs.

*5 years in accordance with our warranty conditions which can be found at www.caravita.eu/warranty

Overview



Central pole parasol selection

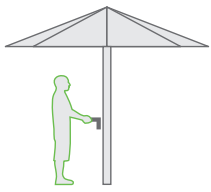

Samara
The parasol with convenient crank mechanism.

12

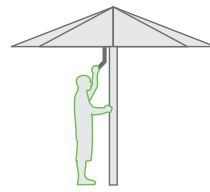

Supremo
Easier to open than any other parasol thanks to a sophisticated sliding mechanism!

18

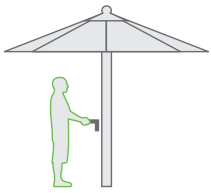

Centro
The easy-to-use centre pole parasol ideal for the food service industry.

24

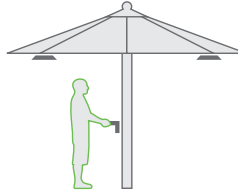

Big Ben
The all-rounder with optional LED light, radiant heaters, motor and more. Also available as a Freestyle version with a made to measure canopy.

30

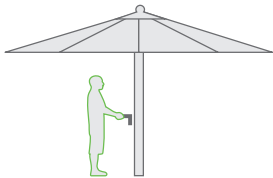

Grande
The large, made to measure parasol – especially for the high demands of the food service industry.

42

Cantilever parasol selection

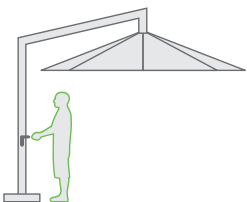

Amalfi
Elegant cantilever parasol with crank mechanism. Also available as a DUO, with two canopies, or as a QUADRO, with four canopies.

48

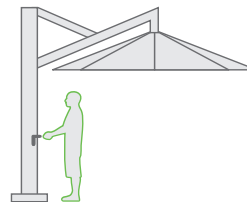

Scala
This cantilever parasol scores points with a large shading area and a whole host of functions.

56

Sun sails

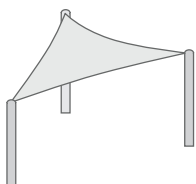

Summerday
The sun sail for home and garden.

64



All Season
The robust All Season sun sail provides shading and defies wind and weather.

70

Multicube

A mobile parasol base for the food service industry

62

Accessories

Parasol base feet, heating, side panels and much more...

76

5 YEAR
WARRANTY*



Samara, 3.5 x 3.5 m, cover 6470, frame colour RAL 7016

*5 years in accordance with our warranty conditions which can be found at www.caravita.eu/warranty



SAMARA

Functional parasol
with crank mechanism

www.caravita.eu/samara

SAMARA



2.5 x 2.5 m, cover 4034 acrylic, silver anodised frame, with wind roof



With its smooth crank mechanism, this shade provider unfolds easily to its true size to welcome guests underneath. Samara dispenses warm sun rays during the day and ensures comfortable temperatures under the parasol in the evening. Even in the largest size, this visually slight parasol is amazingly easy to use.

Your benefits

- + Closes over tables and patio furniture thanks to sophisticated telescopic system
- + Struts made of high-grade aluminium provide wind stability
- + Smooth and reliable crank mechanism

Shapes



Max. size

4 x 4 m

3.5 x 4.5 m

Ø 5 m

Max. shading

16 m²

16 m²

20 m²



Technical details

Operation Smooth crank

Fabric Premium awning fabric in more than 120 colours. 100% acrylic, light-fast and weather-resistant. For information, see p. 92-93. Also available with fireproof fabric or PVC fabric (see p. 93).

Frame White RAL 9016, anthracite grey RAL 7016 or anodised silver, other RAL colours at extra charge

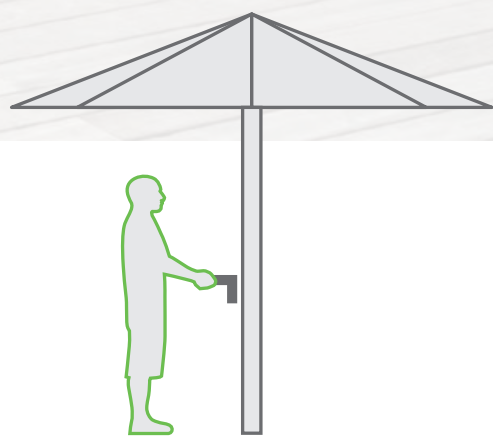

You can find more information on Samara here: www.caravita.eu/samara



SAMARA

High-grade hub

High stability: The Samara parasol is equipped with an especially strong and solid aluminium hub. Powder coating is available in desired RAL colour.

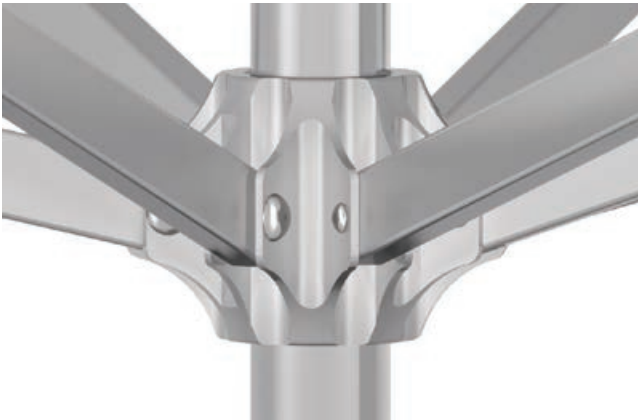

Smooth crank

Extremely easy to use: Samara can be opened and closed with a detachable stainless steel crank. The mechanism inside the pole ensures that the parasol can be closed easily with minimal physical effort.



Sophisticated telescopic system

The advantage: when closing, the telescopic mechanism extends the pole! Tables and patio furniture can simply stay where they are.

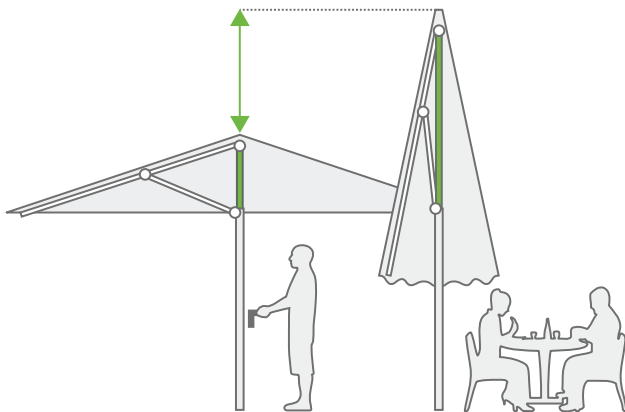

Stable struts

The parasol struts, made of 2 mm thick aluminium tube, are reinforced with special profiles in sections under particular strain.

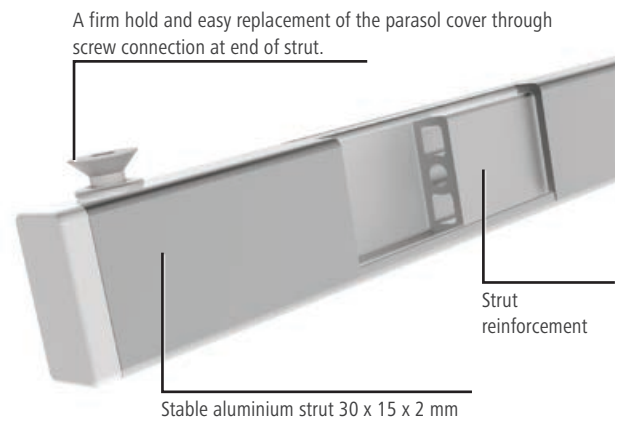

Parasol sizes

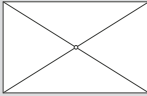
|  |  |  |
|---|---|---|
| 250 x 250 | 200 x 300* | Ø 250 |
| 300 x 300 | 200 x 350* | Ø 300 |
| 350 x 350* | 200 x 400* | Ø 350 |
| 400 x 400* | 250 x 300* | Ø 400 |
| | 250 x 350* | Ø 450* |
| | 250 x 400* | Ø 500* |
| | 300 x 350* | |
| | 300 x 400* | |
| | 300 x 450* | |
| | 350 x 400* | |
| | 350 x 450* | |

* Parasol struts reinforced with special profiles
You can find detailed dimensions for Samara here: www.caravita.eu/samara

5 YEAR
WARRANTY*



Supremo, 4 x 4 m, cover 4017 white, with wind roof
*5 years in accordance with our warranty conditions which can be found at www.caravita.eu/warranty



SUPREMO

Parasol with quick sliding mechanism

www.caravita.eu/supremo

SUPREMO



Supremo, 3.5 x 3.5 m, cover 5800, silver anodised frame, with wind roof



It's so easy – with its sophisticated sliding mechanism, the Supremo opens and closes much more easily and quickly than other parasols, even for large spans. This means Supremo is a welcome addition not only to private gardens and restaurants, but is also suitable for nursery schools and public institutions.

Your benefits

- + Easy-Lift-Balance ensures easy opening in just a few seconds
- + Closes over tables and patio furniture thanks to sophisticated telescopic system
- + High wind stability due to double strut direction

Shapes



Max. size

5 x 5 m

4 x 5 m

Ø 5 m

Max. shading

25 m²

20 m²

20 m²



Technical details

- Operation** Balanced sliding mechanism
- Fabric** Premium awning fabric in more than 120 colours. 100% acrylic, light-fast and weather-resistant. For information, see p. 92-93. Also available with fireproof fabric or PVC fabric (see p. 93).
- Frame** White RAL 9016, anthracite grey RAL 7016 or anodised silver, other RAL colours at extra charge

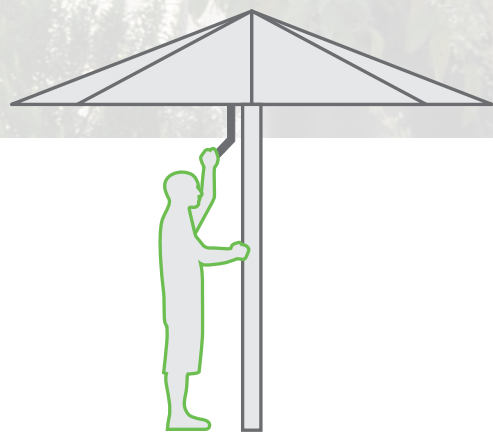

You can find more information on Supremo here: www.caravita.eu/supremo



SUPREMO

Easy-Lift-Balance system

Supremo has a particularly innovative sliding mechanism: With the tap of a finger on the locking switch, the parasol automatically unfolds halfway using its own weight. All that's left to do is lightly push the handle upward and lock it. This system allows for quick and easy handling, even with large parasols.



Struts with double support

The double strut hub provides double support for the main struts, to which the fabric is attached. An interior aluminium profile provides additional strut support for large parasols. This makes the parasol especially robust and wind-stable.



Supremo, 3.5 x 3.5 m, cover 7730 sky blue

Stainless steel handle with locking switch

Quality in every part – the stainless steel handle of the Supremo is not only practical, but also especially stable! When opening and closing the parasol, its locking switch snaps into place automatically.



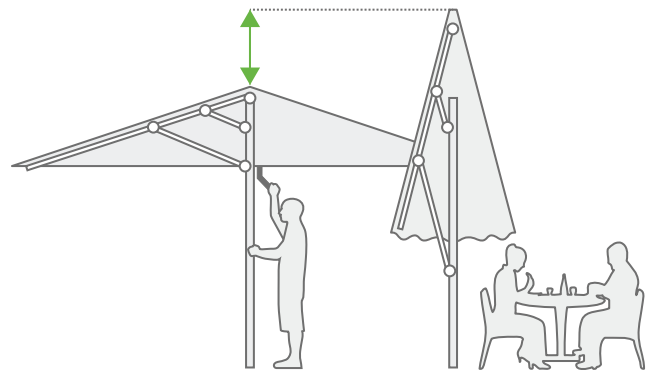

Sophisticated telescopic system

The advantage: when closing, the telescopic mechanism extends the pole! Tables and patio furniture can simply stay where they are.

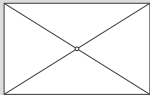

Parasol sizes

|  |  |  |
|---|---|---|
| 300 x 300 | 200 x 350 | Ø 350 |
| 350 x 350 | 200 x 400 | Ø 400 |
| 400 x 400* | 250 x 300 | Ø 450 |
| 450 x 450* | 250 x 350 | Ø 500* |
| 500 x 500* | 250 x 400* | |
| | 250 x 450* | |
| | 300 x 400* | |
| | 300 x 450* | |
| | 300 x 500* | |
| | 350 x 400* | |
| | 350 x 450* | |
| | 350 x 500* | |
| | 400 x 500* | |

* Struts reinforced by additional internal aluminium profile
 You can find detailed dimensions for Supremo here: www.caravita.eu/supremo

5 YEAR
WARRANTY*



Centro, 4 x 4 m, cover acrylic fabric 7400, frame RAL 7021

*5 years in accordance with our warranty conditions which can be found at www.caravita.eu/warranty



CENTRO

Robust restaurant/ho

www.caravita.eu/centro

CENTRO



Centro 4 x 4 m, cover ProNature Brasserie acrylic fabric, frame RAL 7021

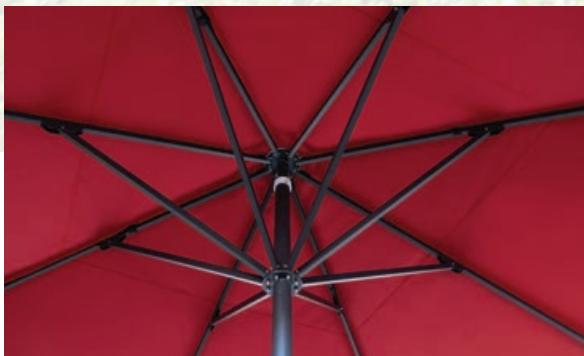

The Centro central pole parasol is a solid sun shading product for parasol sizes up to 5 m span. Ideally suited to beer gardens and patios in the food service industry.

Your benefits

- + Closes over tables and patio furniture thanks to sophisticated telescopic system
- + Smooth opening by crank handle
- + Robust thanks to a strong 70mm diameter pole and struts made of high-grade aluminium

Shapes



Max. size 5 x 5 m

Max. shading 25 m²



Technical details

Operation Crank

Fabric Premium awning fabric in more than 120 colours.
100% acrylic, light-fast and weather-resistant.
For information, see p. 92-93.
Also available with fireproof fabric or PVC fabric (see page 93).

Frame RAL 7016 anthracite grey
RAL 9006 white aluminium

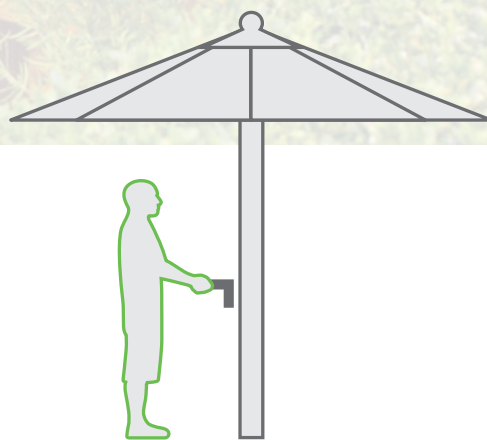

You can find more information on Centro here: www.caravita.eu/centro



CENTRO

High-grade hub

High stability: The Centro parasol is equipped with an especially strong and solid aluminium hub. Powder coating is available in any chosen RAL color with a slight up-charge.



Elegance on the rise

With the battery-powered strut light, consisting of 4 LED strips, power bank, power supply unit and mounting material, Centro invites guests to make themselves comfortable and enjoy the evening even longer.



Sophisticated telescopic system

The advantage: when closing, the telescopic mechanism extends the pole! Tables and patio furniture can simply stay where they are.

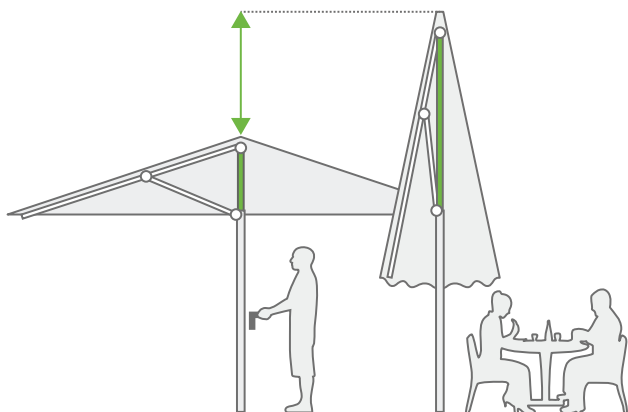

Stable struts

The parasol struts, made of 2 mm thick aluminium tube, are reinforced with special profiles in sections under particular strain.

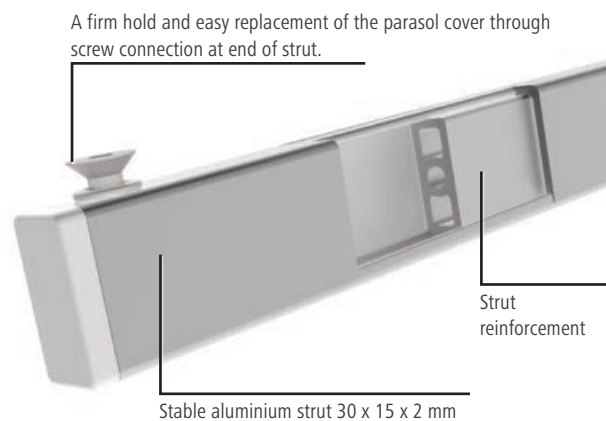

Parasol sizes



400 x 400

500 x 500

Detailed dimensions of Centro can be found at: www.caravita.eu/centro

5 YEAR
WARRANTY*



NEW:
WMS
Motor drive

*5 years in accordance with our warranty conditions which can be found at www.caravita.eu/warranty



BIG BEN

Robust large parasol
for the highest degree of comfort

www.caravita.eu/bigben

Big Ben, 4 x 4 m, cover ProNature Brasserie acrylic fabric, frame RAL 7016 anthracite grey, with wind roof radiant heater and LED lighting

BIG BEN



Big Ben, 4 x 4 m, cover 7850 peppermint, frame RAL 9001 cream, with wind roof



The professional-quality Big Ben large parasol is an eye-catcher for every patio. With its majestic and elegant look it sends a clear signal even from afar: a comfortable, sheltered seat awaits you. With its many extras, high wind stability and a span of up to 7 m, it was specially developed to meet the high demands of the food service and hospitality industries.

Your benefits

- + Professional large parasol spanning up to 7 m
- + Closes over tables and patio furniture thanks to sophisticated telescopic system
- + Extreme wind stability due to solid pole and hub made of high-grade aluminium
- + Many extras: motor operation, radiant heater, LED strut lights and more

Shapes



Max. size

6 x 6 m

5 x 7 m

Ø 7 m

6 m

Max. shading

36 m²

35 m²

38 m²

16 m²



Technical details

- Operation** Via crank mechanism or motor (optionally available with solar panel or WMS radio system)
- Fabric** Premium awning fabric in more than 120 colours. 100% acrylic, light-fast and weather-resistant. For information, see p. 92-93. Also available with fireproof fabric or PVC fabric (see p. 93).
- Frame** RAL colour according to colour chart included
- Options** Including protective cover and telescopic rod

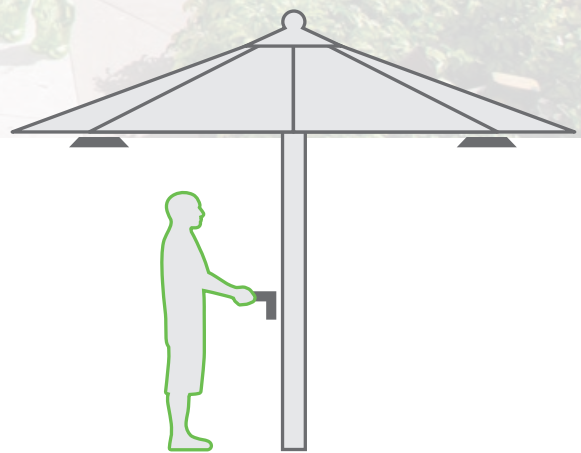

You can find more information on Big Ben here: www.caravita.eu/bigben



BIG BEN

Durable design

Only the best materials and extra strong aluminium profiles are used in the robust design of Big Ben. The solid pole has a diameter of 84 mm and a wall thickness of 5 mm, making it stronger than most others in its class.



Practical alignment guide

This guide greatly simplifies the erection of large parasols. Simply screw adjusting screws into ground sleeve or mobile base. Position the parasol. Thread the alignment guide into the screw and push the parasol up. Then simply screw in place and it's all done.



Parasol sizes



| | | |
|-----------|-----------|-----------|
| 200 x 300 | 300 x 600 | 400 x 650 |
| 200 x 350 | 350 x 400 | 400 x 700 |
| 200 x 400 | 350 x 450 | 450 x 550 |
| 250 x 300 | 350 x 500 | 450 x 600 |
| 250 x 350 | 350 x 550 | 450 x 650 |
| 250 x 400 | 350 x 600 | 450 x 700 |
| 300 x 350 | 350 x 650 | 500 x 550 |
| 300 x 400 | 400 x 450 | 500 x 600 |
| 300 x 450 | 400 x 500 | 500 x 650 |
| 300 x 500 | 400 x 550 | 500 x 700 |
| 300 x 550 | 400 x 600 | |

You can find detailed dimensions for Big Ben here: www.caravita.eu/bigben

Wind-stable up to 100 km/h!

Its solid design makes Big Ben extra robust! To prove this, the professional parasol was tested by structural engineers in a wind tunnel, in which the 3 x 3 m version can withstand even strong winds of up to 100 km/h!



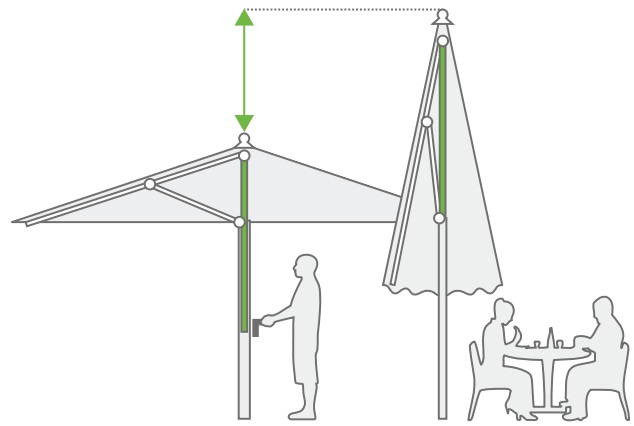

Telescopic system

The advantage: when closing, the telescopic mechanism extends the pole! Tables and patio furniture can simply stay where they are.

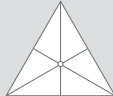

Parasol sizes

|  |  |  |
|---|---|---|
| 300 x 300 | Ø 300 | Ø 300 |
| 350 x 350 | Ø 350 | Ø 350 |
| 400 x 400 | Ø 400 | Ø 400 |
| 450 x 450 | Ø 450 | Ø 450 |
| 500 x 500 | Ø 500 | Ø 500 |
| 550 x 550 | Ø 550 | Ø 550 |
| 600 x 600 | Ø 600 | Ø 600 |
| | Ø 650 | Ø 650 |
| | Ø 700 | |

You can find detailed dimensions for Big Ben here: www.caravita.eu/bigben

BIG BEN optional extras

Radiant heater

Enjoy your favourite outdoor spaces even on cool days with the integrated radiant heaters for Big Ben. Perfectly suited for long evenings – in the food service industry, but also in a private garden. The wiring runs directly in the frame, invisible and well-protected. The detachable radiant heaters are simply plugged into the connections at the strut ends.

Lights and heating can be switched on and off individually using the central switch at the top of the pole.

Hint: order your parasol with pre-equipped wiring. Retrofitting is no longer possible. This way you can remain flexible. We will be happy to advise you on all possibilities regarding weather protection.

Elegance - Integrated strut light

With the integrated Elegance LED strut light, you can make any patio shine! Designed to be elegant and unobtrusive, the modern LED strips provide pleasant light. The lights are easily switched on and off via the central switch on the pole or via remote control. The latter also allows you to dim the lights. Also available with coloured LED light strips.

The light strips can be attached to the underside of the struts just as on the top side for indirect lighting.



Big Ben, 4 x 4 m, cover ProNature Brasserie acrylic fabric, frame RAL 7016 anthracite grey, with wind roof radiant heater and LED lighting

Big Ben with WMS motor

The motorised Big Ben offers top-class convenience! With the press of a button on the remote control, several parasols can easily be opened or closed at the same time – and in only two minutes! An unbeatable advantage for restaurant owners – it's never been so easy to use large parasols.

The clever WMS motor can also be easily networked by radio with other sun shading products. So you have everything under control with just one hand-held transmitter.

Big Ben with solar

As an alternative to the WMS motor, the Big Ben is also available with a self-sufficient solar-powered drive. The solar panel uses solar energy and charges the storage battery integrated in the motor. When fully charged, it has enough power to open and close the canopy at least five times. Ideal if no mains connection or line routing is available.



Big Ben 5 x 5 m, cover 4003, pole DB 703, with solar motor drive, LED lighting and parasol base Multicube (60 cm)

Wind roof

The wind roof differs from the wind hood in that it has an additional frame. This lends the parasol an interesting look and makes it even more resistant to wind.



Cooling system

A spray mist system ensures pleasant temperatures under the parasol. The water pipes are unobtrusively integrated into the pole and frame.

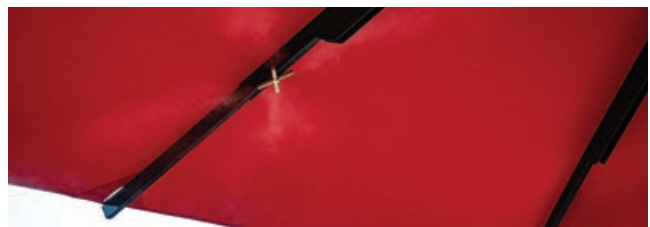

5 YEAR
WARRANTY*





BIG BEN FREESTYLE

High-end parasol made to measure

www.caravita.eu/freestyle

Big Ben FREESTYLE, trapezoid shape 5 x 7 x 2 m, cover acrylic 4017, frame RAL 9016 traffic white
*5 years in accordance with our warranty conditions which can be found at www.caravita.eu/warranty
Picture: Hotel Alpenhof, Oberstdorf (Photographer: Tim Glöckler)

BIG BEN FREESTYLE



Big Ben FREESTYLE, approx. 3.5 x 5.5 m, cover 4026 beige, frame DB-703 fine texture, with LED light strips



Where standard sizes are not enough, Big Ben Freestyle can be used. The professional restaurant parasol is individually produced according to customer requirements. Shape and size can be freely chosen. With a side length of up to 7 m and a surface of up to 36 m², Big Ben Freestyle not only guarantees efficient shading, but also creates real design highlights with its unusual shape!

Your benefits

- + Large parasol with individual shape and size
- + Closes over tables and patio furniture thanks to sophisticated telescopic system
- + Extreme wind stability due to solid pole and hub made of high-grade aluminium
- + Many extras: radiant heater, LED strut lights and more



Technical details

- Operation** Crank mechanism, Motorized on demand and according to technical possibility
- Fabric** Premium awning fabric in more than 120 colours. 100% acrylic, light-fast and weather-resistant. For information, see p. 92-93. Also available with fireproof fabric (see p. 93).
- Frame** RAL colour according to colour chart included
- Technical details** See Big Ben (p. 30–37) Please note that the shorter side of the canopy must be at least half the length of the longer side.

Individual applications

Your Big Ben Freestyle is custom-made to your site requirements. (drawing for the construction project on page 38)

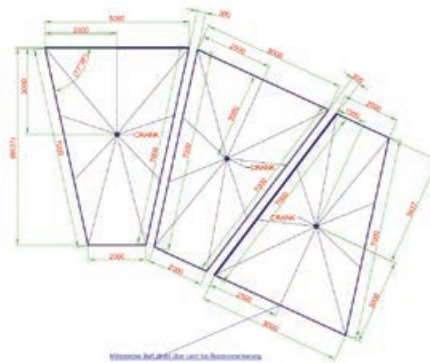

You can find more information about Big Ben Freestyle here: www.caravita.eu/freestyle



5 YEAR
WARRANTY*



Grande, 9 m round, ProNature Brasserie acrylic fabric, frame RAL 7016 anthracite grey, with wind roof
*5 years in accordance with our warranty conditions which can be found at www.caravita.eu/warranty



GRANDE

The giant parasol

www.caravita.eu/grande

GRANDE



Grande, 9 m round, ProNature Brasserie acrylic fabric, frame RAL 7016 anthracite grey, with wind roof

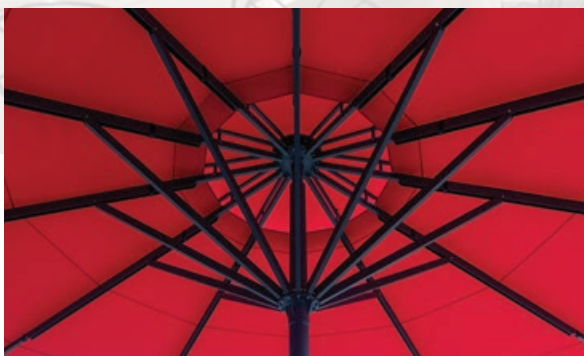

Big, bigger, GRANDE. When standard parasols are no longer enough, the robust central pole parasol scores points with its large spans. In the food service industry, the shading system with an area of up to almost 80 m² offers a pleasant atmosphere for a large number of guests.

Your benefits

- + Closes over tables and patio furniture thanks to sophisticated telescopic system
- + Struts made of high-grade aluminium provide wind stability
- + Smooth and reliable crank mechanism

Shapes



Max. size

8 x 8 m

6 x 8 m

Ø 10 m

Max. shading

64 m²

48 m²

79 m²



Technical details

- Operation** Smooth crank
- Fabric** Premium awning fabric in more than 120 colours. 100% acrylic, light-fast and weather-resistant. For information, see p. 92-93.
- Frame** RAL colour according to colour chart included

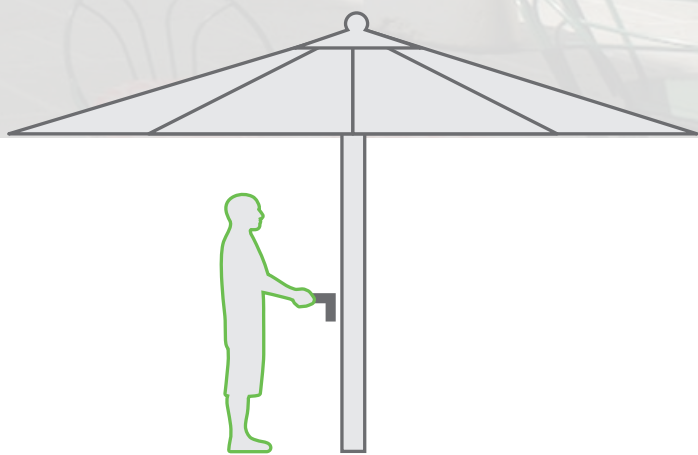

You can find more information about Grande here: www.caravita.eu/grande



GRANDE

Durable design

Only the best materials and particularly strong aluminium profiles are used in the robust construction of the Grande. The solid pole has a diameter of 120 mm and a wall thickness of 5 mm, making it stronger than most others in its class.



Robust anchoring

The pole is fixed to a 450 kg steel plate with several screws. The plate (150 x 150 cm) is placed on a concrete foundation, making the Grande safe and stable in all weather conditions. Alternatively, the parasol can be anchored by means of a ground sleeve.



Grande, 9 m round, ProNature Marfil acrylic fabric, frame RAL 7016 anthracite grey, with wind roof

Sophisticated telescopic system

The advantage: when closing, the telescopic mechanism extends the pole! Tables and patio furniture can simply stay where they are.

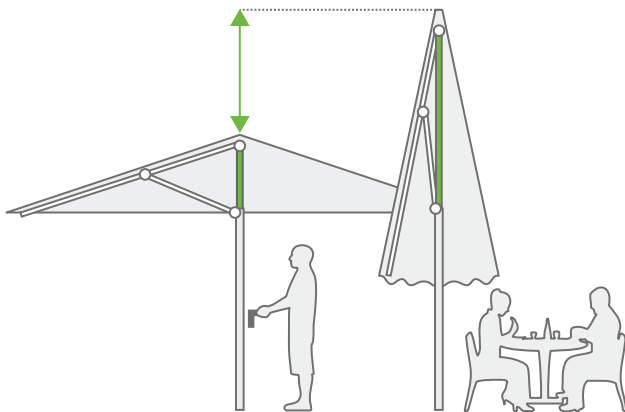

Power struts

The parasol struts made of strong 60 x 30 mm aluminium with additional U-reinforcements provide wind stability even at high spans.

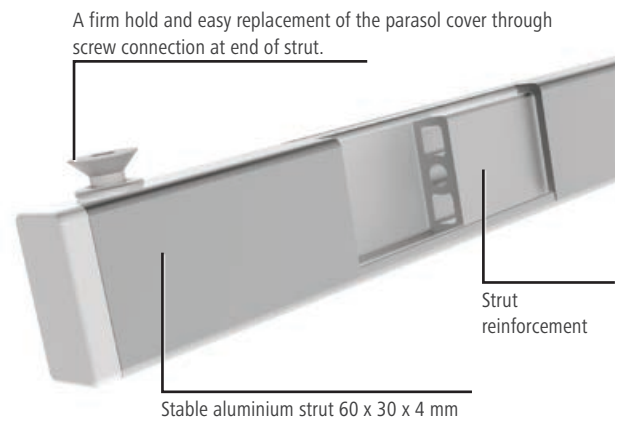

Parasol sizes

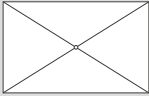
|  |  |  |
|---|---|---|
| 650 x 650 | 400 x 800* | Ø 750 |
| 700 x 700 | 500 x 800* | Ø 800 |
| 750 x 750* | 600 x 700* | Ø 850 |
| 800 x 800* | 600 x 800* | Ø 900 |
| | | Ø 950* |
| | | Ø 1000* |

* Parasol struts reinforced with special profiles
Detailed dimensions of Grande can be found at: www.caravita.eu/grande

5 YEAR
WARRANTY*



Amalfi, 3.5 x 3.5 m, cover ProNature Apricot acrylic fabric, frame RAL 7016 anthracite
*5 years in accordance with our warranty conditions which can be found at www.caravita.eu/warranty



AMALFI

Elegant cantilever parasol

www.caravita.eu/amalfi

AMALFI



Amalfi, 3.5 x 3.5 m, cover ProNature Brasserie acrylic fabric, frame RAL 7016 anthracite grey



The Amalfi canopy sways freely, seemingly weightless. The pole of the parasol stands laterally, thus creating plenty of space for tables and chairs. While the sun may wander during the day, the shade remains exactly where it is needed. With the optional stainless steel rotary base, the Amalfi can be rotated 360° without having to move the base.

Your benefits

- + Robust aluminium frame for high wind stability
- + Smooth integrated crank winch
- + pole for wall installation available
- + Optional with stainless steel rotary base
- + Optionally available with two or four canopies

Shapes



| | | | |
|---------------------|-------------------|-------------------|-------------------|
| Max. size | 3.5 x 3.5 m | 3 x 4 m | Ø 4 m |
| Max. shading | 12 m ² | 12 m ² | 12 m ² |



Technical details

- Operation** Crank or motor
- Fabric** Premium awning fabric in more than 120 colours. 100% acrylic, light-fast and weather-resistant. For information, see p. 92-93. Also available with fireproof fabric or PVC fabric (see p. 93).
- Frame** RAL colour according to colour chart included

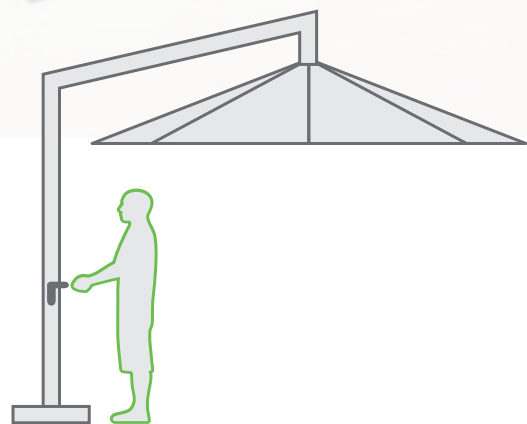

You can find more information on Amalfi here: www.caravita.eu/amalfi



AMALFI

Motor drive

With its electric motor drive, Amalfi now opens and closes even faster and more conveniently. The push button is conveniently integrated directly on the motor housing on the pole. (Sensors and other control components cannot be supplemented.)



Optional: stainless steel rotary base

Sophisticated mechanism: The rotary base made of stainless steel, rotatable by 360°, is screwed directly onto the ground sleeve or the parasol base. The rotating function is conveniently unlocked by pressing on the pedal. When the pedal is released, the mechanism engages and holds the parasol in position.

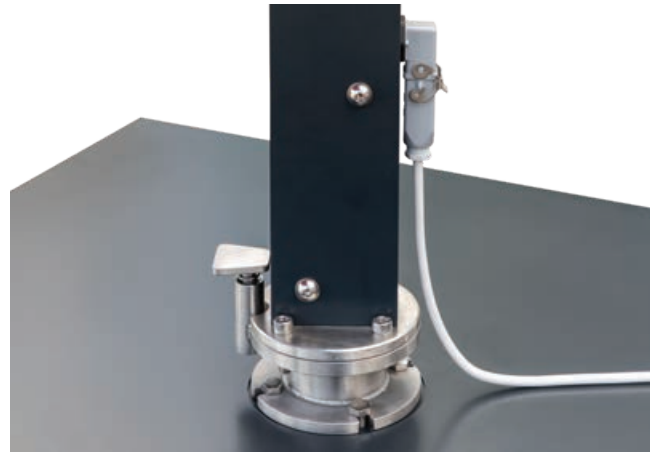

Amalfi 3.5 x 3.5 m, cover 7390 acrylic fabric, frame RAL 7016 anthracite grey

Smooth crank winch

Amalfi opens and closes very easily with the smooth crank winch. Self-locking holds the parasol in any position.





Space-saving wall installation

Save space by mounting the Amalfi to walls and railings. The High-Power pole with 60 mm and 4 mm wall thickness is produced for you exactly according to your requirements, such as the wall installation height, the desired crank height etc. After closing the parasol, the Amalfi can be turned to the side to save space.

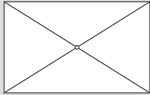

Parasol sizes

|  |  |  |
|---|---|---|
| 200 x 200 | 200 x 300 | Ø 250 |
| 250 x 250 | 200 x 350 | Ø 300 |
| 300 x 300 | 200 x 400 | Ø 350 |
| 350 x 350 | 250 x 300 | Ø 400 |
| | 250 x 350 | |
| | 250 x 400 | |
| | 300 x 350 | |
| | 300 x 400 | |

You can find detailed dimensions for Amalfi here: www.caravita.eu/amalfi

AMALFI DUO 1 & 2

Double the space in the shade

Amalfi DUO 1 carries two canopies at once on a central High-Power pole with 70 mm and 4 mm wall thickness. It shades even large surfaces elegantly, creating two separate areas with its central pole. The two canopies can be opened independently of each other as required.

Amalfi DUO 2 combines the charm of a classic cantilever parasol with the robustness of a large parasol. The powerful 150 mm pole is laterally offset, so that the shaded area can be used flexibly e.g. for long tables, individual seat groups or a row of sun loungers beside the pool. Both canopies can be opened independently of each other.



Parasol sizes

| | | | | |
|-------|-----------|------------|--|-------|
| Duo 2 | | | | |
| Duo 1 | | | | |
| | 200 x 200 | 200 x 300 | | Ø 250 |
| | 250 x 250 | 200 x 350 | | Ø 300 |
| | 300 x 300 | 200 x 400* | | Ø 350 |
| | 350 x 350 | 250 x 300 | | Ø 400 |
| | | 250 x 350 | | |
| | | 250 x 400* | | |
| | | 300 x 350 | | |
| | | 300 x 400* | | |

You can find detailed dimensions for Amalfi here: www.caravita.eu/amalfi

* not available in DUO 2 model

You can find inspiration and reference images for Amalfi DUO und Amalfi QUADRO at www.caravita.eu/amalfi

AMALFI QUADRO

Quadruple the space in the shade

With its four floating canopies, Amalfi QUADRO provides a light and fresh ambiance for large terraces. Whether relaxing with a cup of coffee, dining in style with friends or enjoying an ice cream sundae with the kids – Amalfi QUADRO creates enough space for all your guests with up to 49 m² of shade.

Elegant, classic design and utmost functionality make a stylish combination. Each of the four canopies can be opened independently of the others as required.



Parasol sizes

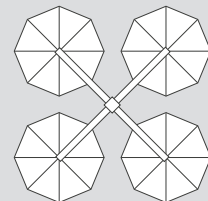
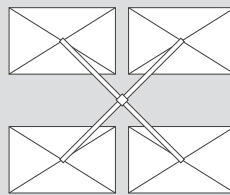
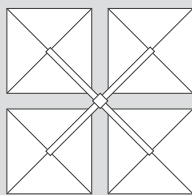

200 x 200

250 x 300

Ø 250

250 x 250

300 x 350

Ø 300

300 x 300

Ø 350

350 x 350

Ø 400

You can find detailed dimensions for Amalfi here: www.caravita.eu/amalfi

5 YEAR
WARRANTY*



Scala, 4 x 4 m, cover 4013, frame RAL 9016

*5 years in accordance with our warranty conditions, which can be found at www.caravita.eu/warranty



SCALA

Function meets design

www.caravita.eu/scala

SCALA



Scala, 4 x 4 m, cover 4017 white, frame RAL 9016



With its optional rotating pedal as well as its WMS motor drive on demand, this elegant canilever parasol adds even more details to its flexibility. With a span of 4 m and its modern design, Scala is definitely not to go unnoticed on any terrace.

Your benefits

- + Strong aluminium frame ensures longevity
- + Canopy closed on the pole to save space
- + Flexible thanks to rotatable pole
- + Unique look and high-grade components
- + Optionally available with motor drive

Moulds



Max. size 4 x 4 m

Max. shading 16 m²



Technical details

- Operation** Crank or WMS Radio motor
- Fabric** Premium awning fabric in more than 120 colours. 100% acrylic, light-fast and weather-resistant. For information, see p. 92-93. Also available with fireproof fabric (see p. 93).
- Frame** RAL colour according to colour chart included

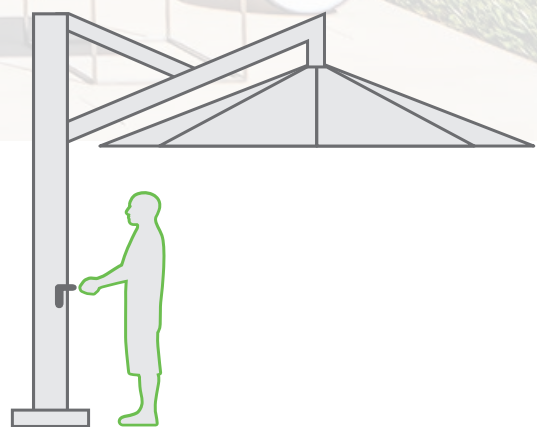

You can find more information about Scala here: www.caravita.eu/scala



SCALA

Smooth crank winch

Scala opens and closes effortlessly with the smooth crank winch. Self-locking holds the parasol in any position. As an option this cantilever parasol can also be operated by our WMS motor.



Stainless steel rotary base

Sophisticated mechanism: The rotary base made of stainless steel, rotatable by 360°, is screwed directly onto the ground sleeve or the parasol base. The rotating function is conveniently unlocked by pressing on the pedal. When the pedal is released, the mechanism engages and holds the parasol in place.



Sustainable construction

Scala is made of high-grade aluminium components. Its frame is therefore durable and wind-stable and can be powder-coated in any RAL colour.



Space-saving

Thanks to its elegant design, the Scala canopy closes directly on the pole and does not interfere with patio or garden furniture.



Parasol sizes



350 x 350

400 x 400

Detailed dimensions of Scala can be found at: www.caravita.eu/scala

MULTICUBE



Additional standing and seating space



The Gabione Multicube is made up of robust steel cages with wood covering and is the ideal replacement for conventional parasol bases with flagstones. The mobile Multicube creates a comfortable atmosphere for additional guests and ensures flexibility when arranging your outdoor area – without having to install ground sleeves.

Your benefits

- + Mobile thanks to lifting device for pallet truck
- + Individual size, colour and filling can be selected
- + Ideal for advertising
- + Easy to retrofit



Colour options for wooden seat covering (softwood, triple sealed)



ecru



light brown

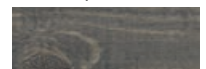

anthracite

Cushion colour versions



warm beige



soft stone



storm grey



5 YEAR
WARRANTY*



Multicube

Product information

- Steel cage made of double-bar mesh mats, galvanised with floor
- Suitable for all CARAVITA parasol bases with flagstone dimensions 40 cm x 40 cm
- Fill dimensions: approx. 34 cm x 34 cm
- With softwood covering

Multicube sets

- Consisting of four individual Multicubes
- Including sheet base Monaco 8, Dublin 8 or Dublin 16
- Robust wooden chair with triple varnish in desired colour

Sizes (height)

40 cm, 60 cm, 80 cm

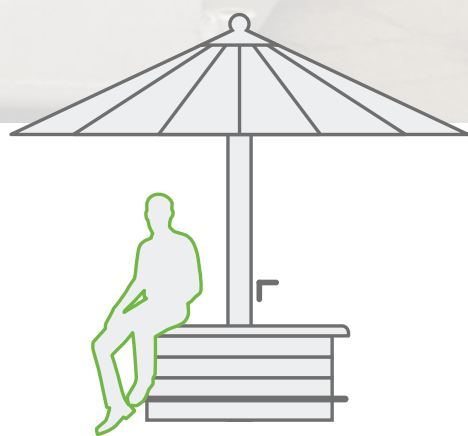

More information on the Multicube and on using the lifting device can be found here www.caravita.eu/multicube







SUMMERDAY

Mobile sun sail

www.caravita.eu/summerday

SUMMERDAY

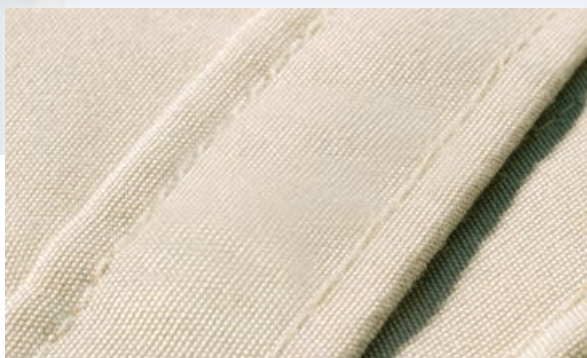

Under the protection of the Summerday sun sail, you can enjoy the nicest days of the year even more. Relax and take a break in your favourite spot. The Summerday sun sail stands out in terms of its uncomplicated structure and high quality processing.

Your benefits

- + Light and mobile
- + Extra strong corners
- + Tailor-made to customer wishes

Shapes Individual and standard sizes (p. 69)

Max. size 6 m lateral edge
(additional sizes upon enquiry)

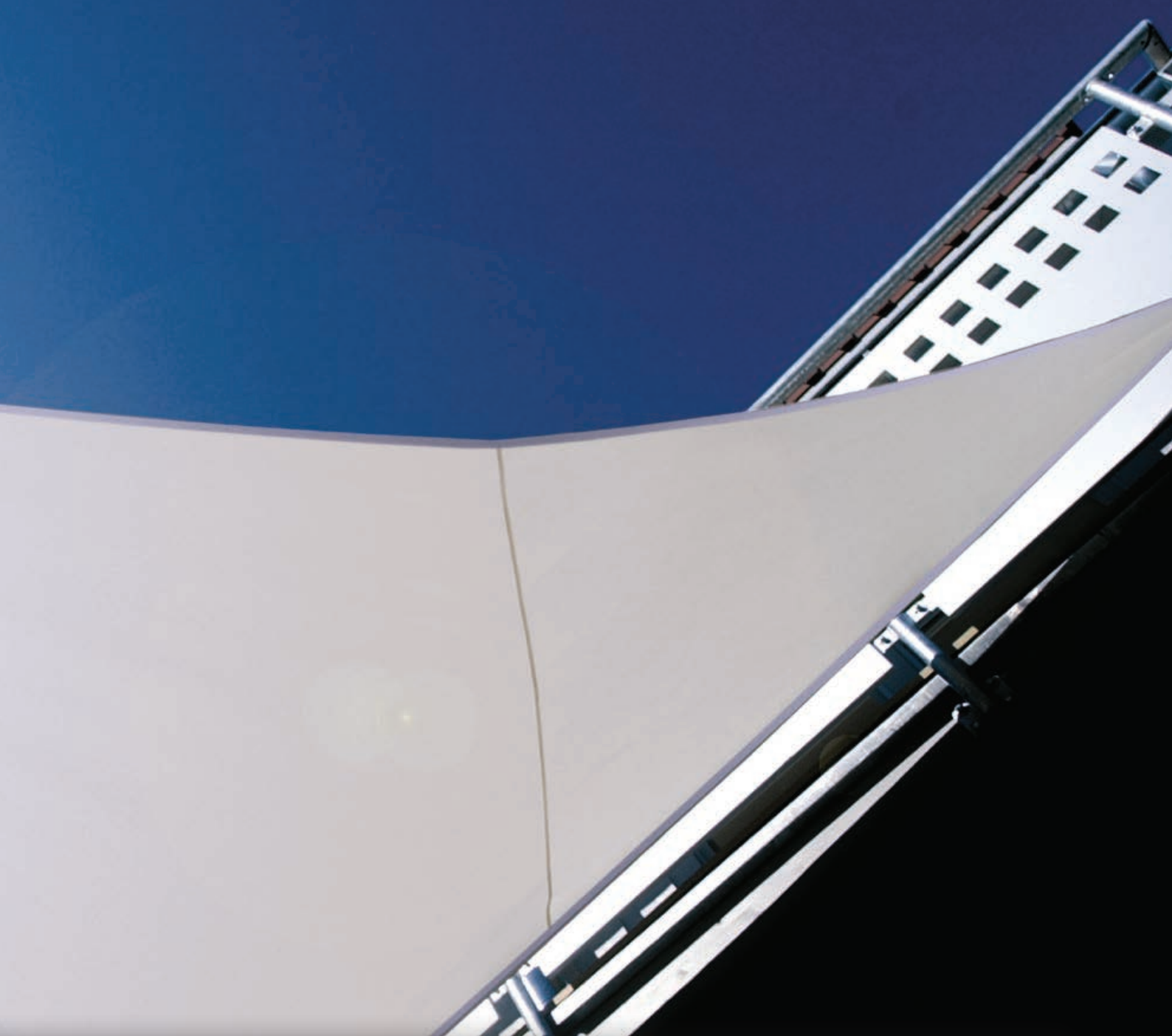

Technical details

Fabric

Premium awning fabric in more than 120 colours. 100% acrylic, light-fast and weather-resistant. For information, see p. 92-93. Also available in Tentmesh (see p. 92).

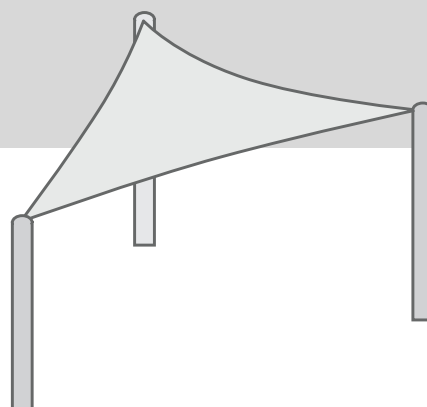

You can find more information on Summerday here: www.caravita.eu/summerday



SUMMERDAY

Aluminium pole Ø 50 mm

Available in colours white RAL 9016, anthracite RAL 7016, anodised silver, or at extra cost in other RAL colours as per the colour chart. The poles are reinforced with an internal zinc-coated steel pole for increased load capacity. Combinable with ground sleeve Europa or Pianura.



Stainless steel pole Ø 57 mm

These stainless steel poles can be anchored in the ground in two ways. If the pole is to be combined with Europa KU or LU ground sleeves, please indicate this when ordering. Otherwise the pole can be set directly in concrete.



Standard sail shapes and dimensions

| Triangle, equilateral | Square | Freestanding rectangle |
|---|---|---|
|  |  |  |
| 300 x 300 x 300 | 300 x 300 | 300 x 400 |
| 350 x 350 x 350 | 350 x 350 | 300 x 500 |
| 400 x 400 x 400 | 400 x 400 | 400 x 500 |
| 450 x 450 x 450 | 450 x 450 | |
| 500 x 500 x 500 | 500 x 500 | |
| 550 x 550 x 550 | 550 x 550 | |
| 600 x 600 x 600 | 600 x 600 | |

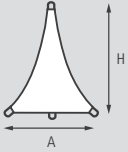
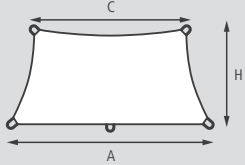
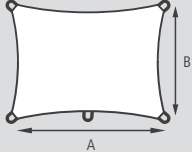
| Triangle for wall installation | Trapezoid for wall installation | Rectangle for wall installation |
|---|---|---|
|  |  |  |
| A 300 / H 250 A 400 / H 450 | A 300 / H 200 / C 200 | A 300 / B 250 |
| A 300 / H 300 A 400 / H 500 | A 300 / H 300 / C 200 | A 350 / B 300 |
| A 300 / H 350 A 450 / H 400 | A 350 / H 300 / C 250 | A 400 / B 250 |
| A 300 / H 400 A 450 / H 450 | A 350 / H 350 / C 250 | A 400 / B 300 |
| A 350 / H 300 A 450 / H 500 | A 400 / H 300 / C 300 | A 400 / B 350 |
| A 350 / H 350 A 500 / H 400 | A 400 / H 350 / C 300 | A 450 / B 300 |
| A 350 / H 400 A 500 / H 450 | A 500 / H 300 / C 400 | A 450 / B 350 |
| A 350 / H 450 A 500 / H 500 | A 500 / H 350 / C 400 | A 450 / B 400 |
| A 350 / H 500 | A 500 / H 400 / C 400 | A 500 / B 300 |
| A 400 / H 350 | | A 500 / B 350 |
| A 400 / H 400 | | A 500 / B 400 |

Tips for planning your sun sail can be found at www.caravita.eu





ALL SEASON

Sun sail for all weather

www.caravita.eu/allseason

ALL SEASON



The All Season sun sail provides comfortable shading the whole year. Thanks to its robust design it is also ideally suited for large areas. The storm-proof sail is suitable for use not only in your own garden, but is also perfectly suited to nursery schools and playgrounds.

Your benefits

- + Storm-proof design
- + Tailor-made to customer wishes
- + Permanent installation
- + Suitable for particularly large sails

Shapes Individual

Max. size 72 m² (additional sizes upon enquiry)



Technical details

Fabric

Water-permeable HDPE net fabric in 16 colours. The robust fabric, permeable for water and air, filters up to 98% of UV rays. The colour chart for the Tentmesh HDPE fabric can be found at www.caravita.de

Robust processing

Welded fabric webs with 6 mm stainless steel sail with circular hem. Double reinforced corners made of solid stainless steel with tensioning device. All tension cables can be adjusted individually.



You can find more information on All Season here: www.caravita.eu/allseason



ALL SEASON

Stainless steel pole Ø 108

pole with 4 mm wall thickness for setting in concrete directly. Anchoring with a ground sleeve is not possible. A flat stainless steel finial top is included in the price. The final height above ground decreases in accordance with the installation depth.



Steel pole Ø 102

pole with 5 mm wall thickness for setting in concrete directly. Anchoring with a ground sleeve is not possible. A flat steel finial top is included in the price. The final height above ground decreases in accordance with the installation depth.



Three-way turnbuckle

A solid stainless steel three-way turnbuckle functions as a corner fixing for the especially robust design (adjustment range: approx. 10 cm). The surrounding edges are traversed by a 6 mm thick stainless steel cable. The fabric made of stable HDPE netting is permeable for water and air but filters up to 98% of UV rays.



Easy planning

It's easier than you think to plan a sun sail. To start, the fixing points of the sail must be determined. Then you can determine the dimensions of the sail with a cord. More detailed tips for planning your sun sail can be found at: www.caravita.eu/planning-sun-sail/

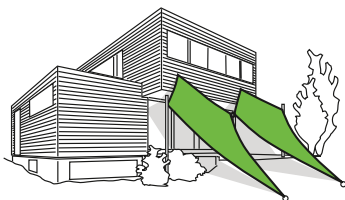
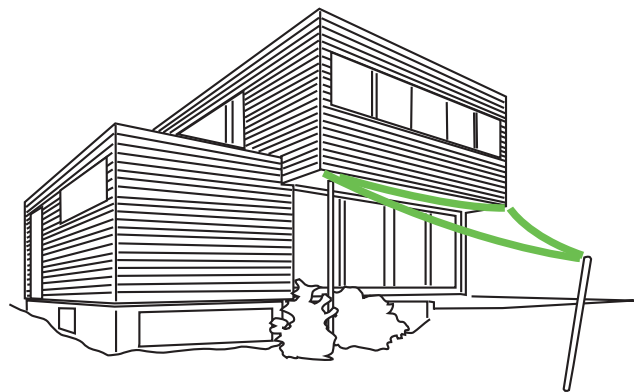

Sail made up of two diamonds

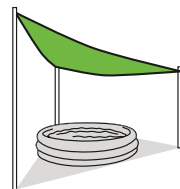

Triangle sail above paddling pools

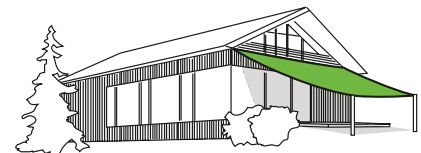

Trapezoid sun sail for patio shading

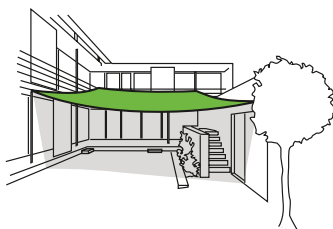

square sun sail above courtyard

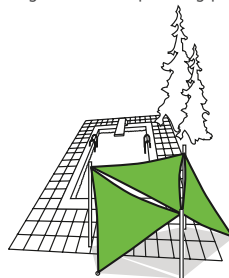

Sun shading, wind protection and visual privacy at the pool

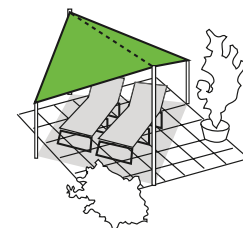

Freestanding Butterfly

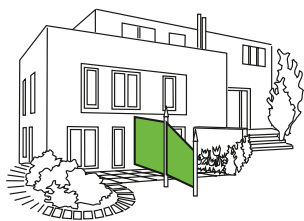

Vertically tensioned sail for visual privacy

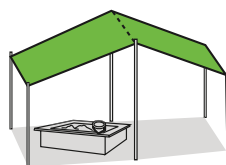

Roof gable made of rectangular sail

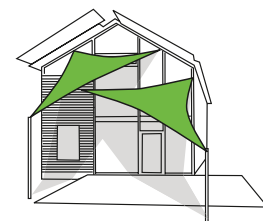

Patio and facade shading

Tips for planning your sun sail can be found at www.caravita.eu

Parasol bases

Mobile bases

| Model name | Net weight | Samara & Supremo | Big Ben, Amalfi & Amalfi DUO 1, Centro, Scala | Amalfi DUO 2 & Amalfi QUADRO | Material | Page |
|-------------------|------------|------------------|---|------------------------------|----------|------|
| Verona 100 Air | 100 kg | ✓ | – | – | Concrete | 78 |
| Turin 100 Air | 100 kg | ✓ | – | – | Concrete | 78 |
| Paris 85* | 85 kg | ✓ | – | – | Concrete | 79 |
| Rome 90* | 90 kg | ✓ | – | – | Granite | 79 |
| Oslo Z / P** | 42 kg | ✓ | – | – | Steel | 79 |
| Geneva Z / P** | 85 kg *** | ✓ | – | – | Steel | 79 |
| Monaco 4 Z / P** | 25 kg *** | ✓ | – | – | Steel | 80 |
| Monaco 8 Z / P** | 35 kg *** | ✓ | – | – | Steel | 80 |
| Monaco 16 Z / P** | 60 kg *** | ✓ | – | – | Steel | 80 |
| Dublin 8 Z / P** | 30 kg *** | – | ✓ | – | Steel | 80 |
| Dublin 16 Z / P** | 50 kg *** | – | ✓ | – | Steel | 80 |
| Dublin 24 Z / P** | 77 kg *** | – | ✓ | – | Steel | 80 |
| Boston 24 Z / P** | 77 kg *** | – | – | ✓ | Steel | 81 |
| BB sheet Z / P** | 39 kg | – | ✓ | – | Steel | 81 |
| BBE plate Z / P** | 39 kg | – | ✓ | – | Steel | 81 |

* Available with wheels for a surcharge.

** Z: zinc-coated, P: powder-coated.

*** Weight without plates. Sheet weight approx. 20 kg each, depending on material.

**** Without pole fitting for Belvedere with stainless steel rotary base.

***** Only possible with adapter plate

Spacing extension

Adapters (height 10 to 60 cm) are available on request as attachments for the parasol bases of Big Ben, Grande, Centro and Scala.

Recommended weight for mobile parasol bases**

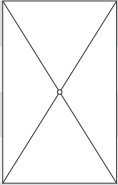
| Parasol shape | Size | Recommended weight | Possible with these parasol bases |
|--|-----------------------------------|--------------------|---|
|  | up to 3.5 m | 170 kg | Dublin 8 with 8 flagstones* / Monaco 8 with 8 flagstones* |
| | up to 4 m | 200 kg | Dublin 16 with 12 flagstones* / Monaco 16 with 12 flagstones* |
| | up to 4.5 m | 250 kg | Dublin 16 with 12 flagstones* / Monaco 16 with 12 flagstones* |
| | up to 5 m | 290 kg | Dublin 16 with 16 flagstones* / Monaco 16 with 16 flagstones* |
| | up to 5.5 m | 340 kg | Dublin 16 with 16 flagstones* / Monaco 16 with 16 flagstones* |
| | up to 6 m | 400 kg | Dublin 24 with 16 flagstones* |
| | up to 6.5 m | 450 kg | Dublin 24 with 16 flagstones* |
| | up to 7 m | 500 kg | Dublin 24 with 24 flagstones* |
|  | up to 3 x 3 m | 170 kg | Dublin 8 with 8 flagstones* / Monaco 8 with 8 flagstones* |
| | up to 3.5 x 3.5 m | 200 kg | Dublin 16 with 12 flagstones* / Monaco 16 with 12 flagstones* |
| | up to 4 x 4 m / 4 x 2 m / 4 x 3 m | 250 kg | Dublin 16 with 12 flagstones* / Monaco 16 with 12 flagstones* |
| | up to 4.5 x 4.5 m / 5 x 3 m | 290 kg | Dublin 16 with 16 flagstones* / Monaco 16 with 16 flagstones* |
| | up to 5 x 5 m / 5 x 4 m / 6 x 3 m | 390 kg | Dublin 24 with 16 flagstones* |
| | up to 7 x 5 m | 470 kg | Dublin 24 with 24 flagstones* |

This information serves as guidelines. For higher loads e.g. positions exposed to wind, ground sleeves or Multicubes are recommended. the specified weights can be reduced through use of standard ground anchors with load transfer.

* standard concrete flagstones 40 x 40 x 5 cm with approx. 18.4 kg
** for side arm parasols, select one size category higher

Pole fittings and ground sleeves

| Model name | Net weight | Samara & Supremo | Big Ben, Amalfi & Amalfi DUO 1, Centro, Scala | Amalfi DUO 2 & Amalfi QUADRO | Grande | Material | Page |
|---------------------|------------|------------------|---|------------------------------|--------|---------------------------|------|
| Pianura K / L | 5 / 9 kg | ✓ | – | – | – | Stainless steel | 82 |
| Europa K / L | 3 / 4 kg | ✓ | – | – | – | Stainless steel | 82 |
| Bern Z / P* / A2*** | 3 kg | ✓ | – | – | – | Stainless steel/ steel | 83 |
| BBK / BBL | 3 / 7 kg | – | ✓ | – | – | Stainless steel | 84 |
| BBKE / BBLE | 7 / 11 kg | – | ✓ | – | – | Stainless steel | 84 |
| AQ / AL 150 | 7 / 12 kg | – | – | ✓ | – | Stainless steel | 85 |
| Mounting foundation | 14 kg | ✓ | ✓ | – | – | Galvanised steel | 85 |
| GY base plate | 450 kg | – | – | – | ✓ | Galvanised steel | 46 |
| GY ground sleeve | 12 kg | – | – | – | ✓ | Stainless steel | 85 |

* Z: zinc-coated, P: powder-coated.

** Only for Belvedere with stainless steel rotary base

*** Also available with locking pin.

Parasol bases

Verona 100 Air

Mobile parasol stand with wheels made of concrete with plastic cover in anthracite or graphite

Extras: Flexible clamping

Weight 100 kg
Size 75 x 75 cm
ø Pole 45 - 68 mm



| Samara | Supremo |
|--------|---------|
| ✓ | ✓ |

Turin 100 Air

Mobile parasol stand with wheels made of concrete with plastic cover in anthracite or graphite

Extras: Quick release

Weight 100 kg
Size 75 x 75 cm
ø Pole 50 - 55 mm



| Samara | Supremo |
|--------|---------|
| ✓ | ✓ |

Paris 85

Square concrete base with handle shells. Weather-proof stainless steel pole.

Weight 85 kg
 Size 590 x 590 x 120 mm
 ø Pole 25–55 mm



| Samara | Supremo |
|--------|---------|
| ✓ | ✓ |

Rome 90

Refined granite bases with handle shells; unscrewable and weather-proof stainless steel pole; polished surface in grey.

Weight 90 kg
 Size ø 700 mm
 ø Pole 25–55 mm

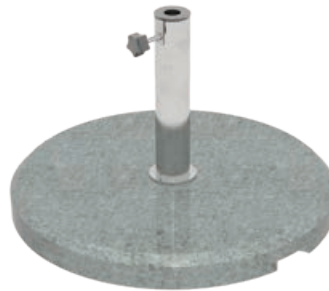

| Samara | Supremo |
|--------|---------|
| ✓ | ✓ |

Oslo

Oslo Z: Galvanised steel sheet with pole fitting. Oslo P: With additional powder coating in desired RAL colour.

Weight 42 kg
 Size 700 x 700 x 10 mm
 ø Pole 50 mm



Oslo P

| Samara | Supremo |
|--------|---------|
| ✓ | ✓ |

Geneva

Geneva Z: Galvanised steel sheet with pole fitting. Geneva P: With additional powder coating in desired RAL colour.

Weight 85 kg
 Size 1000 x 1000 x 10 mm
 ø Pole 50 mm

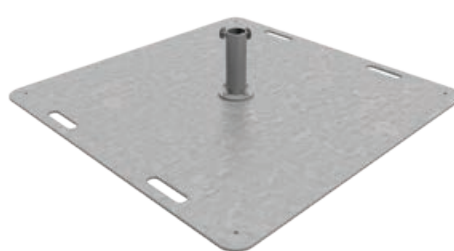

Geneva Z

| Samara | Supremo |
|--------|---------|
| ✓ | ✓ |

Parasol bases

Monaco 4 / 8 / 16

Mobile sheet base made of steel for the insertion of concrete slabs with dimensions 40 x 40 x 5 cm (not included in delivery). With 4 leveling screws. Depending on the model, up to 16 concrete slabs can be inserted. Sheet bases can be remounted when using cantilever parasols. Without pole fitting, suitable for Belvedere with stainless steel rotary base.

Weight of steel frame 25 kg / 35 kg / 60 kg
 Size 1000 x 1000 x 50 / 100 / 200 mm
 ø Pole 50 mm

Monaco Z: Galvanised.
 Monaco P: With additional powder coating in desired RAL colour.

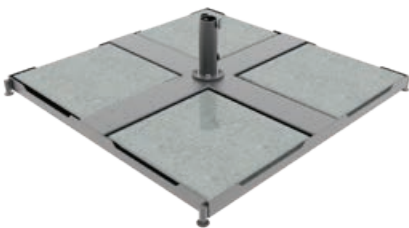

Monaco 4 P

| Samara | Supremo |
|--------|---------|
| ✓ | ✓ |

Dublin 8 / 16 / 24

Mobile sheet base made of galvanised steel for the insertion of concrete slabs with dimensions 40 x 40 x 5 cm (not included in delivery). With 4 leveling screws. Depending on the model, up to 24 concrete slabs can be inserted.

Dublin Z: Galvanised.
 Dublin P: Galvanised with additional powder coating in desired RAL colour.

Weight of steel frame 30 kg / 50 kg / 77 kg
 Size 1000 x 1000 x 100 / 200 / 300 mm

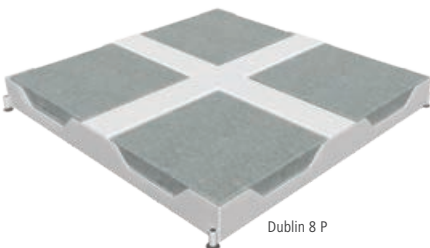

Dublin 8 P

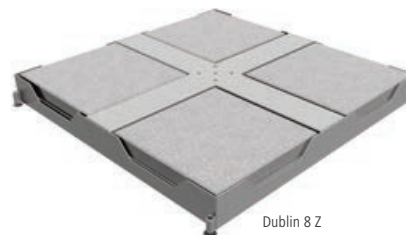

Dublin 8 Z

| Big Ben | DUO 1 | Amalfi | Centro | Scala |
|---------|-------|--------|--------|-------|
| ✓ | ✓ | ✓ | ✓ | ✓ |

Boston 24

Like Dublin, but with different drilled holes for mounting Amalfi DUO 2 and Amalfi QUADRO.

Weight of steel frame 50 kg / 77 kg
 Size 1000 cm x 1000 cm x 200 / 300 mm

Boston Z: Galvanised.

Boston P: Galvanised with additional powder coating in desired RAL colour.

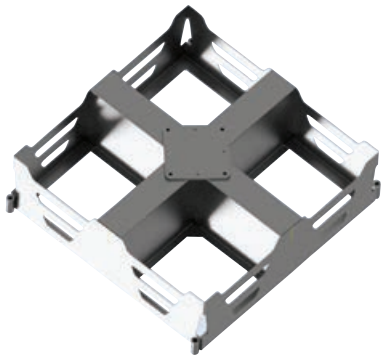

| DUO 2 | QUADRO |
|-------|--------|
| ✓ | ✓ |

BB sheet

BB sheet Z: Galvanised steel plate with drilled holes.

BB sheet P: With additional powder coating in desired RAL colour.

Weight 39 kg
 Size 700 x 700 x 10 mm

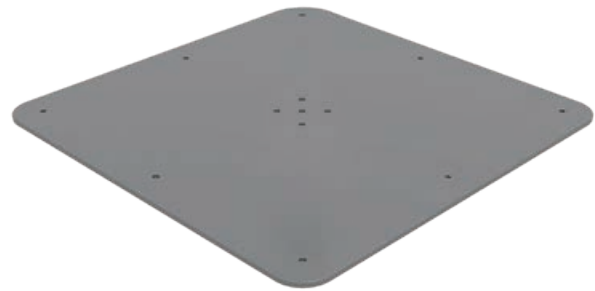

BB sheet P

| Centro | Big Ben | DUO 1 | Amalfi | Scala |
|--------|---------|-------|--------|-------|
| ✓ | ✓ | ✓ | ✓ | ✓ |

Alucase

Available for Dublin 8 and Monaco 8 in powder-coated finish.

Weight 8.5 kg
 Size 1000 x 1000 x 100 mm

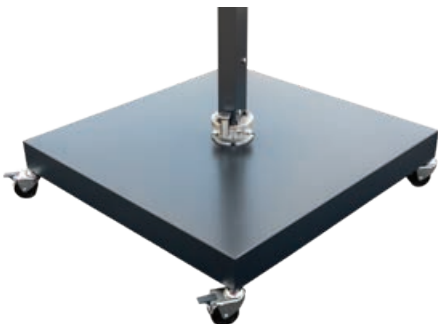

Parasol bases

Ground sleeve Pianura K and L

Stainless steel ground anchor to be set in concrete, with pole fitting. The upper pole fitting can be unscrewed. The bottom part remaining in the ground is then at ground level.

For Belvedere with stainless steel rotary base, choose Pianura KU/LU.

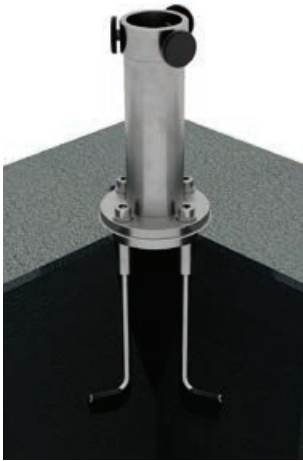

Short model K

Length 35 cm, \varnothing pole 50 mm. The standard solution for normal concrete foundations. The size of the foundation should be minimum 60 x 60 x 60 cm.

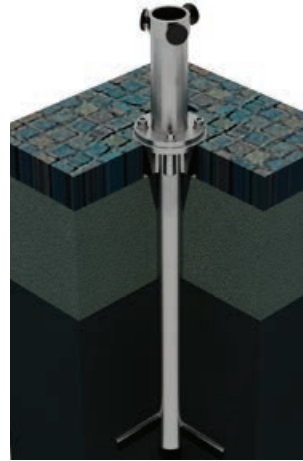

Long model L

Length 61 cm, \varnothing pole 50 mm. A special solution for paved ground or other special cases in which soft earth, sand or air between the foundation and the ground must be bridged.

| Samara | Supremo |
|--------|---------|
| ✓ | ✓ |

Ground sleeve Europa

Stainless steel ground sleeve to be set in concrete. The upper part of the ground sleeve can be removed. The practical closure cap is held permanently closed by a spring.

The bottom part remaining in the ground is then at ground level. With theft protection. Without pole fitting, suitable for Belvedere with stainless steel rotary base.

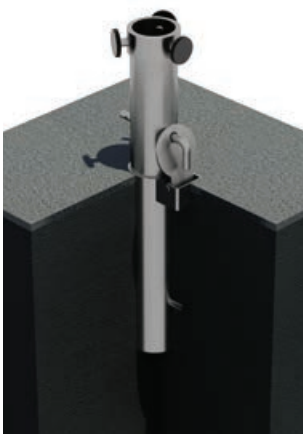

Short model K

Length 25 cm, \varnothing pole 50 mm. The standard solution for normal concrete foundations. The size of the foundation should be minimum 60 x 60 x 60 cm.

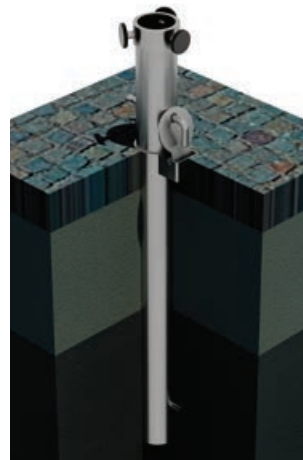

Long model L

Length 50 cm, \varnothing pole 50 mm. A special solution for paved ground or other special cases in which soft earth, sand or air between the foundation and the ground must be bridged.

| Samara | Supremo |
|--------|---------|
| ✓ | ✓ |

Pole fitting Bern

Bases to be screwed on. Available in 3 models (from left to right).
A2: stainless steel, Z: galvanised, P: powder-coated. Model P can be painted in any RAL colour.

Weight 3 kg
Height 200 mm
Ø Pole 50 mm



| Samara | Supremo |
|--------|---------|
| ✓ | ✓ |

Parasol bases

Ground sleeves

The unobtrusive solution for setting in concrete for fixed parasol locations. Big Ben is screwed stably to the sleeve with four screws. If the parasol is removed, the sleeve forms a discreet seal at ground level.

Short model BBK

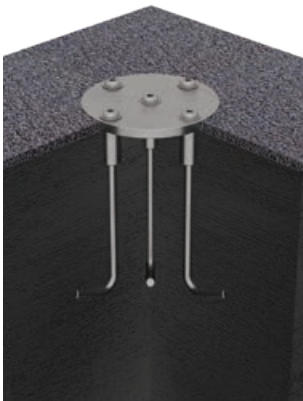

Length 35 cm. The standard solution for normal concrete foundations. The size of the foundation should be minimum 80 x 80 x 80 cm.

Long model BBL

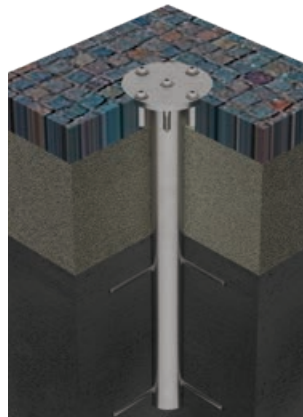

Length 61 cm. A special solution for paved ground or other special cases in which soft earth, sand or air between the foundation and the ground must be bridged.

| Centro | Big Ben | Amalfi | DUO 1 | Scala |
|--------|---------|--------|-------|-------|
| ✓ | ✓ | ✓ | ✓ | ✓ |

Ground sleeves with electrical connection

Practical power supply for Big Ben – without any tangled cables. The mains connection is kept safe in the waterproof housing. Initial installation must be performed by an electrician.

Ground sleeves with connection for...

- 230 V for light and/or motor.
- 400 V once radiant heater comes into use.

Short model BBKE



Length 35 cm. The standard solution for normal concrete foundations. The size of the foundation should be minimum 80 x 80 x 80 cm.

Long model BBLE



Length 61 cm. A special solution for paved ground or other special cases in which soft earth, sand or air between the foundation and the ground must be bridged.

| Big Ben | Amalfi | Scala |
|---------|--------|-------|
| ✓ | ✓ | ✓ |

Ground sleeves

Stainless steel ground sleeve AL

Length 61 cm. A special solution for paved ground or other special cases in which soft earth, sand or air between the foundation and the ground must be bridged.

Weight 12 kg
Length 610 mm
Size 240 x 240 mm



| DUO 2 | QUADRO |
|-------|--------|
| ✓ | ✓ |

GY ground sleeve

Weight 12 kg
Length 610 mm
Size 240 x 240 mm



| Grande |
|--------|
| ✓ |

Mounting foundation

Galvanised metal pole with spiral thread to be screwed into the ground. Can be used on all stable ground. Extremely stable. Suitable for permanent installation but still easily recyclable.

Weight 14 kg
Length 1300 mm
Ø 140 mm



| Samara | Supremo | Centro | Big Ben | Amalfi | DUO 1 | Scala |
|--------|---------|--------|---------|--------|-------|-------|
| ✓ | ✓ | ✓ | ✓ | ✓ | ✓ | ✓ |

Weather protection

With CARAVITA, you can enjoy time outdoors even in rainy weather, on cold days and late at night. CARAVITA offers many options to create your individually customised weather protection solution:

Keep your guests dry

Moderate to high rain protection can be achieved by choosing the right fabric. For private use, acrylic awning fabric is usually sufficient. Restaurant owners often opt for the more dense All Weather or Ferrari Preconstraint 302. Drainage gutters can close the gaps between different parasols. Side panels protect against drafts and lateral rainfall.

Create a warm oasis

Detachable infrared radiant heaters can be easily mounted on your parasol. The Big Ben parasol can be equipped with an integrated heating system to provide a professional solution, whereby the cables run safely and discreetly inside the parasol.

Turn night into day

Big Ben parasol lighting creates a stylish ambiance on your terrace. Professionals opt for the Big Ben parasol with integrated Elegance lighting system including dimmer and remote control.

Rain gutter

Tip: Order this useful weather protection device at the same time so that you can always flexibly retrofit it.



Rain gutter Free

As a Free variant, the rain gutter can also only be attached to a parasol.



Details of the individual options can be found on the following pages.



Lighting and heating (p. 36 – 37)



Side panels (p. 87)



CARAVITA parasol fabrics (p. 91 – 93)

Side panels



Closed side panels

Optional door available for all types and versions.

Side panels with transparent windows

Also available with mosquito net.

Complete your parasol with side panels made of premium awning fabric or other high-grade special materials. Side panels are available in different models: closed, with mosquito net or transparent plastic film window. All models are also available with a door.

| Samara* | Supremo* | Big Ben* |
|---------|----------|----------|
| ✓ | ✓ | ✓ |

* only with support poles



Attaching the side panel

Side panels are attached to the parasol struts with carabiner clips. Hook-and-loop strips connect parasols and side panels seamlessly.

Not possible without strut support



Lux type: aluminium poles in hem

Lux type side panels have a hollow seam for inserting aluminium poles. These provide additional stability for the side panels.

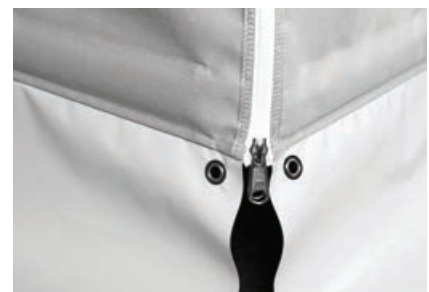

Connected by zipper

The individual side panels can be joined together with a zipper. This transforms the parasol into a pavilion in the blink of an eye.

Advertising printing



Screen printing

Screen printing process is perfect for printing on acrylic fabrics. Your logo or motif can include up to 4 colours (without halftone printing).

Please request a free, non-binding quotation if required.

Parasol Configurator

Are you looking for the right parasol?

The CARAVITA Configurator helps you choose. You choose the type of parasol, the colour and the fabric of the canopy, the appearance of the pole and all the accessories – and with one click your new virtual parasol appears before you. It really is that easy to choose a parasol!

Easily design your personal parasol at www.caravita.eu/configurator



| |
|-----------------|
| Model ▾ |
| Shape ▾ |
| Size ▾ |
| Fabric colour ▾ |
| Frame colour ▾ |
| Valance ▾ |
| Accessories ▾ |

PDF Download

Find dealers



Fabrics

Quality for long lasting out door fun.

Only premium-quality fabrics from leading manufacturers are used for CARAVITA parasols. These fabrics offer outstanding weather resistance alongside optimal sun protection features.

What protection factor is ideal for you?



The UV protection factor (UPF) indicates the sun protection effect of the parasol fabric. The higher the value, the better the protection.

| Type | Features | Safe direct sun exposure time in minutes | Safe sun exposure with parasol in minutes | | |
|------|--|--|---|-----------|-------------|
| | | | UPF 12 | UPF 30 | UPF 50+ |
| 1 | Light skin, freckles, blonde or red hair, blue or green eyes | 5 – 10 | 60 – 120 | 150 – 300 | 250 – 500 |
| 2 | Light skin, blonde hair, blue or green eyes | 10 – 20 | 120 – 240 | 300 – 600 | 500 – 1000 |
| 3 | Dark hair, blue eyes | 20 – 30 | 240 – 360 | 600 – 900 | 1000 – 2000 |
| 4 | Dark skin, dark or black hair, dark eyes | ~ 45 | ~ 540 | ~ 1350 | ~ 2250 |
| 5 | Dark skin, black hair | ~ 60 | ~ 720 | ~ 1800 | ~ 3000 |
| 6 | Black skin, black hair, black eyes | ~ 90 | ~ 1080 | ~ 2700 | ~ 4500 |

Discover the wide range of CARAVITA fabrics at www.caravita.eu/colours



Fabrics

Acrylic fabric



The tried and tested acrylic awning fabric is manufactured from 100% spinning nozzle dyed brand acrylic fabric. That means that the colour pigments – unlike in classic yarn dyeing – are applied during the fibre production. This ensures reliable protection against damaging UV radiation and permanently guarantees brilliant colours / constant weather and light-fastness. Furthermore, the acrylic fabric is especially tear-resistant and also dirt and water-repellent thanks to its impregnation with a special protective agent. The reliable solution for long-term outdoor use.

- Water-proof from 300 - 370 mm water column, EN 20811
- High colour and weather fastness (7 - 8) of 8
- Water and dirt-repellent
- 100% acrylic fabric 285 – 300 g/m²
- Commercial printing possible on canopy and valance



These colours are also available in **All Weather** quality. All the advantages of acrylic fabric. Water-proof up to 1000 mm water column, EN 20811.

Tentmesh

Tentmesh is a net made of UV-resistant flat and HDPE yarns. Depending on the colour, it reduces UV rays by 91% to 98% and sunrays by 77% to 96%. Because Tentmesh is water-permeable, this fabric is the optimal solution for designing flat tensioned sails. Parasols that are used all year round can also be covered with Tentmesh.

- Parasols with an edge length of up to 4 m can be covered with Tentmesh. Not compatible with Big Ben Freestyle.
- Net made of UV-resistant flat and HDPE yarns
- Reduces UV rays by 91% to 98%
- Reduziert Sonnenstrahlen zwischen 77 % – 96 %
- Optimally suited for light membrane structures
- Surface weight: approx. 340 g/m²

LUMERA acrylic fabric

The innovative Lumera acrylic fabric is woven with the special CBA fibre (Clean Brilliant Acrylic). Along with all the benefits of the acrylic fabric, this provides even more bonuses. The acrylic multifilament fibre has a smoother and denser surface. This means that the colours turn out richer and more radiant and the fabric's luminance is increased for a long time.

- Water-proof up to 460 mm water column, EN 20811
- High colour and weather fastness (7 - 8) of 8
- Water and dirt-repellent
- 100% acrylic fabric 290 g/m²
- Commercial printing possible on canopy and valance



Ferrari Precontraint 302

This PVC-coated sun protection membrane is particularly robust and durable. Absolute water impermeability and high flame resistance are two further features to be appreciated.

- Not compatible with Big Ben Freestyle and Belvedere
- Polyester mesh with PVC coating
- Absolutely waterproof
- Dirt-repellent
- Flame resistant (B1 as per DIN 4102)
- High colour fastness (7 - 8 of 8, DIN EN ISO 105-B02)
- Surface weight: 480 g/m²
- Commercial printing possible on canopy and valance



TempotestStar FR

The TempotestStar fabric collection from PÀRA is a highly flame resistant fabric, which meets the recognised building materials class B1. The 100% spinning nozzle dyed, high-grade polyester is available in many colours and is a specialised solution for applications in which fire safety plays a central role.

- Building materials class B1 (DIN 4102)
- Oil, water and dirt-repellent
- High colour and weather fastness (7 - 8 of 8 DIN EN ISO 105 B04)
- Water-proof up to 300 mm water column, UNI EN 20811
- 100% spinning nozzle dyed polyester 300 g/m²



ProNature acrylic fabric



With ProNature acrylic fabric, CARAVITA offers an innovation that has it all: the fabric treated with a finish provides clean air. Photocatalysis is used to eliminate pollutants such as nitrogen oxides, sulphur oxides and organic substances, thereby neutralising odours. For simply more sustainable quality of life. The specifications of this ingenious fabric are the same as for the conventional, tried-and-tested acrylic fabric.

- Water-proof from 300 - 370 mm water column, EN 20811
- High colour and weather fastness (7 - 8) of 8
- Water and dirt-repellent
- 100% acrylic fabric 285 – 300 g/m²
- Commercial printing possible on canopy and valance

Learn more at www.caravita.eu/nature

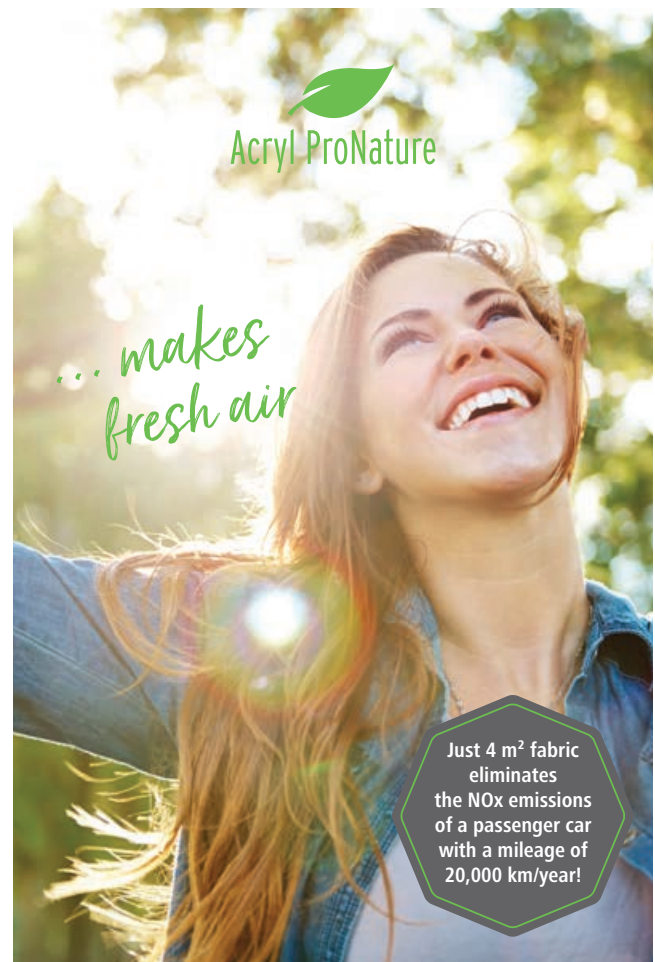

Impressions



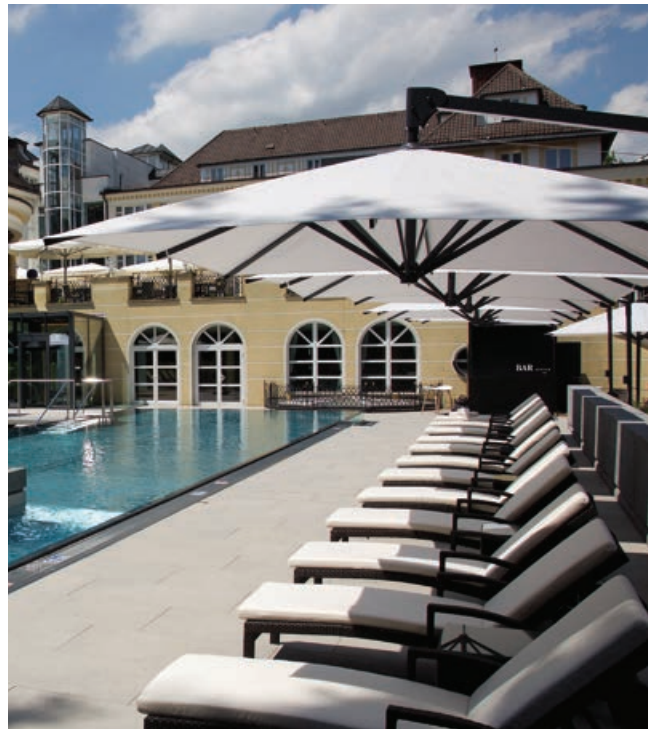

Warranty conditions

1. General information

By purchasing a CARAVITA product, the contracting partner of CARAVITA GmbH is entitled to statutory warranty claims. These claims are not restricted by a warranty.

2. Period of warranty

In addition to statutory claims, CARAVITA GmbH grants a warranty service to the contracting partner for a period of 5 years from the date of invoice.

3. Effectiveness of warranty

The warranty service is valid in all member states of the European Union.

4. Warranty protection

The warranty service includes:

- The functionality of the frame profile
- The functionality of the connecting elements
- The colour-fastness of the parasol fabric (aging processes of the fibres by more than one point on the colour-fastness scale after light-fastness (DIN EN ISO 105-B02))

The following parasol models of the Selection Series are covered by the warranty:

- BigBen
- Amalfi
- Grande
- Supremo
- Samara
- Scala
- Centro

5. Exclusion of the warranty

Damage or defects due to improper use or failure to comply with the installation instructions or instructions for use are not covered by this warranty.

6. Establishment of contact in the event of a warranty case

When discovered, a warranty claim must be reported to:

**CARAVITA GmbH, Am Augraben 21, 85080 Gaimersheim,
Phone: +49 8458 603890**

7. Service in the event of a warranty case

Defects in the product components covered by the warranty will be assessed within a reasonable period of time after notification of the defect and will be eliminated free of charge if the warranty conditions are met.

The expenditure required for this purpose, specifically transport, travel, labour and materials will be borne by us.

Claims beyond this improvement are not granted by this warranty. Wherever possible, improvement works will be performed at the installation site. Otherwise, they will be performed at our customer service workshop.

Warranty services do not extend or reset the warranty period for this device; replaced parts become the property of CARAVITA.

Dated: 01.01.2021

Perea pergola awnings and Lamaxa slat roofs from WAREMA



WAREMA Lamaxa L70



WAREMA Perea P40



WAREMA Perea P70



Find out more at: www.warema.com

Notes



CARAVITA®

Part of
WAREMA GROUP

www.caravita.eu

Subject to modifications. No liability for printing errors.

Selection_2000_EN_01.02.2022